

3D Objects

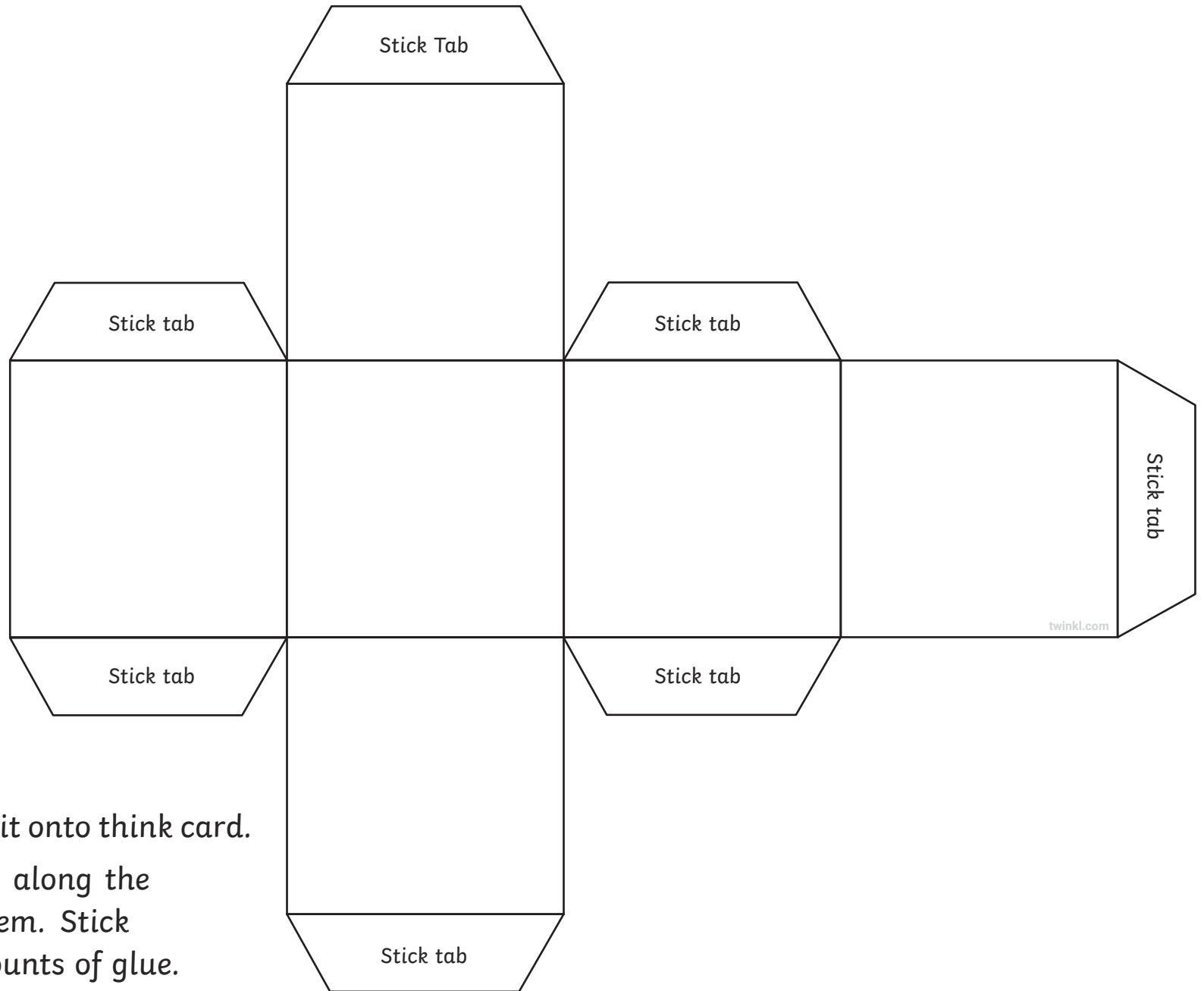

This is a net for a cube.

Print it out and then stick it onto a card.

Cut it out and then score along the dotted lines and fold them. Stick together with small amounts of glue.

3D Objects

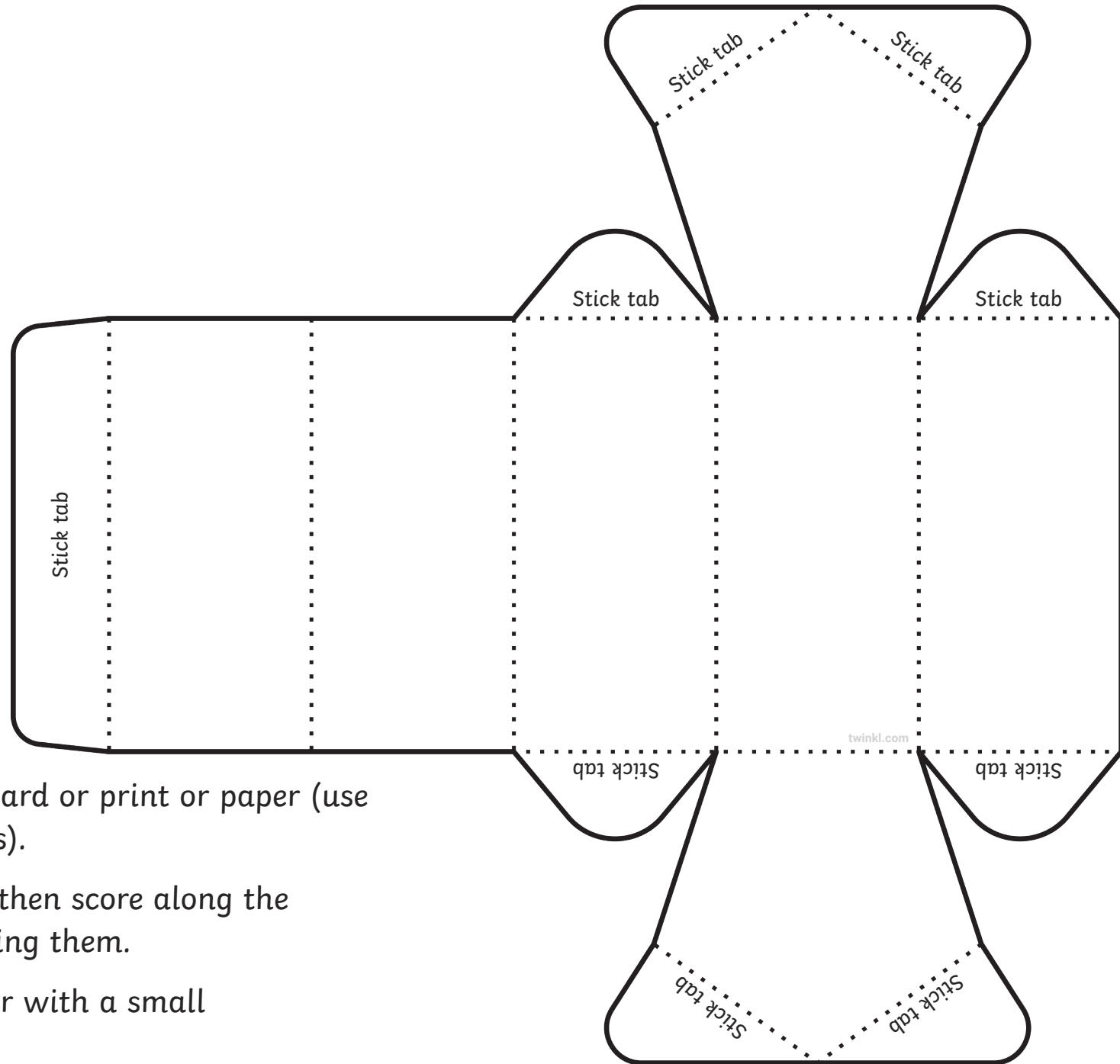

Print the template on card or print on paper (use card for the best results).

Cut the shape out and then score along the dotted lines before folding them.

Stick the shape together with a small amount of glue.

3D Objects

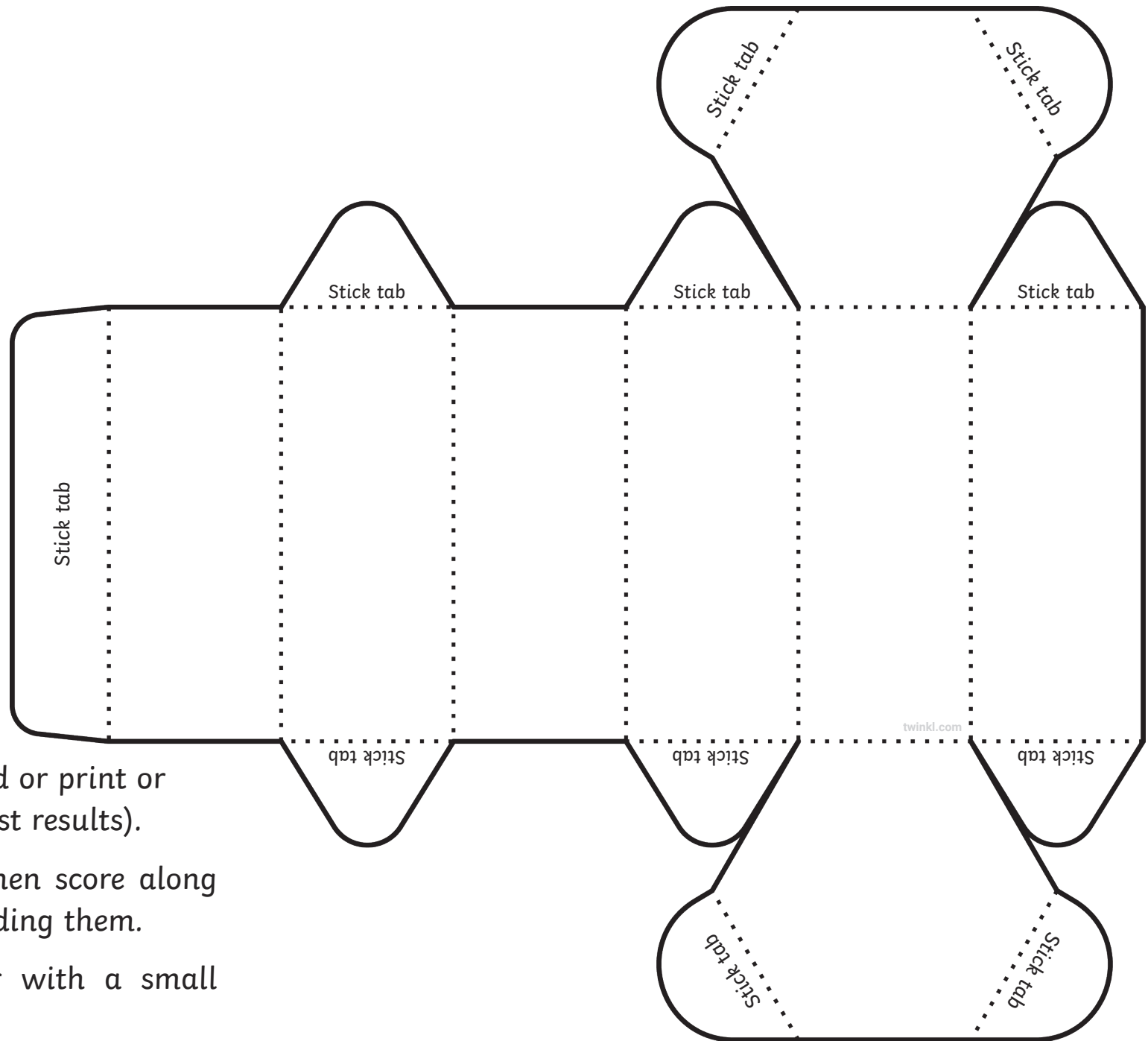

Print the template on card or print on paper (use card for the best results).

Cut the shape out and then score along the dotted lines before folding them.

Stick the shape together with a small amount of glue.

3D Objects

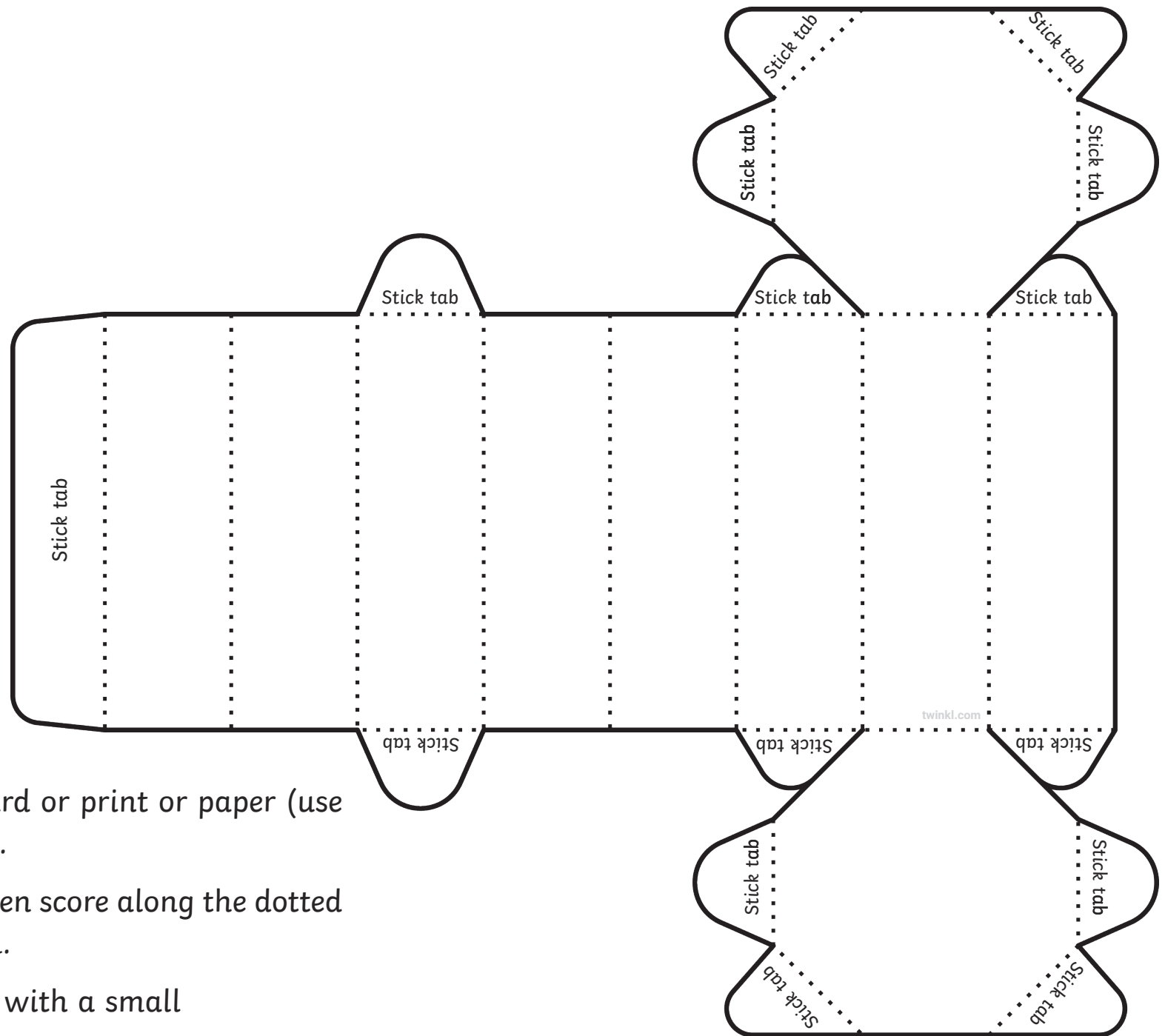

Print the template on card or print on paper (use card for the best results).

Cut the shape out and then score along the dotted lines before folding them.

Stick the shape together with a small amount of glue.

3D Objects

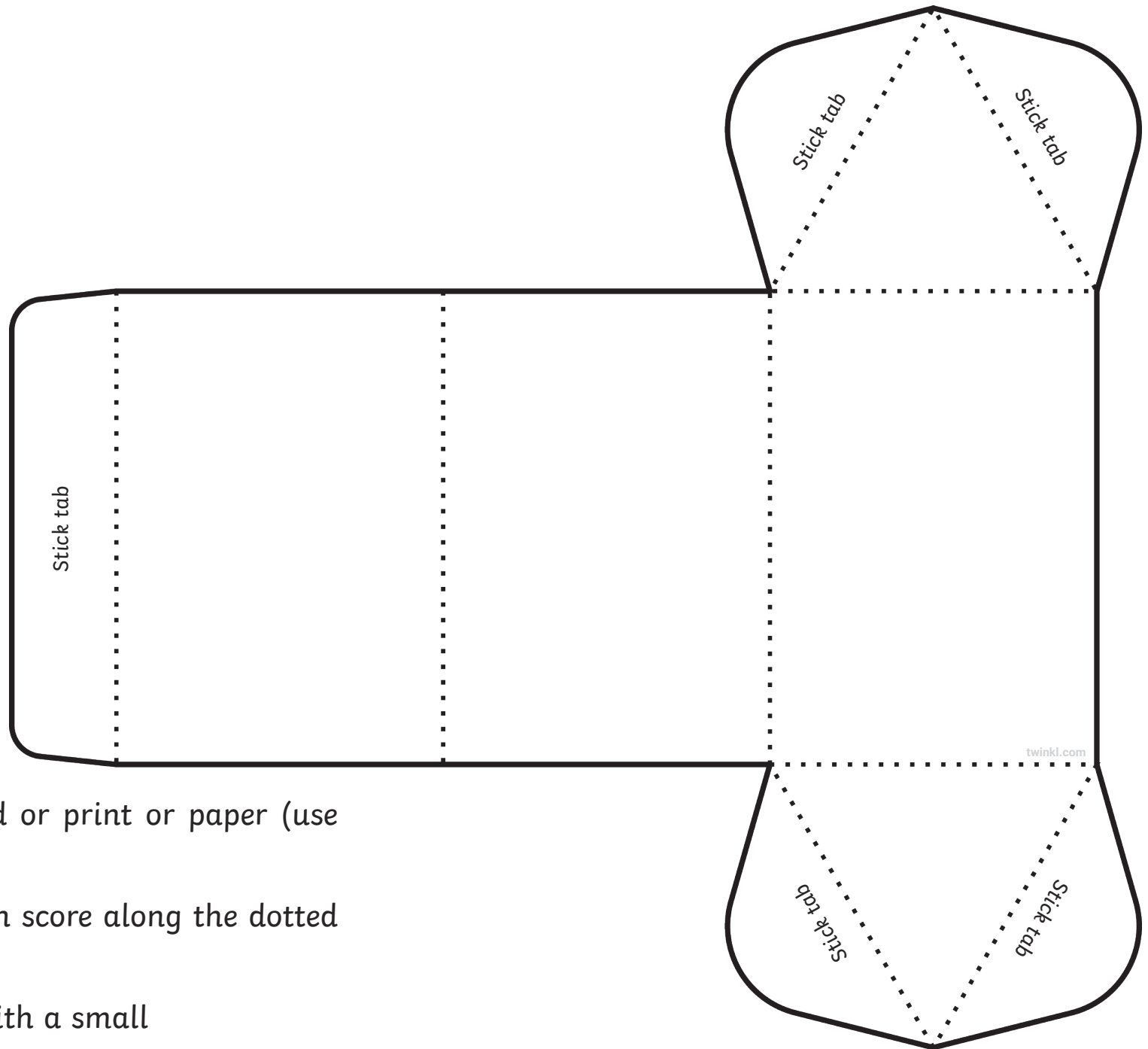

Print the template on card or print on paper (use card for the best results).

Cut the shape out and then score along the dotted lines before folding them.

Stick the shape together with a small amount of glue.

3D Objects

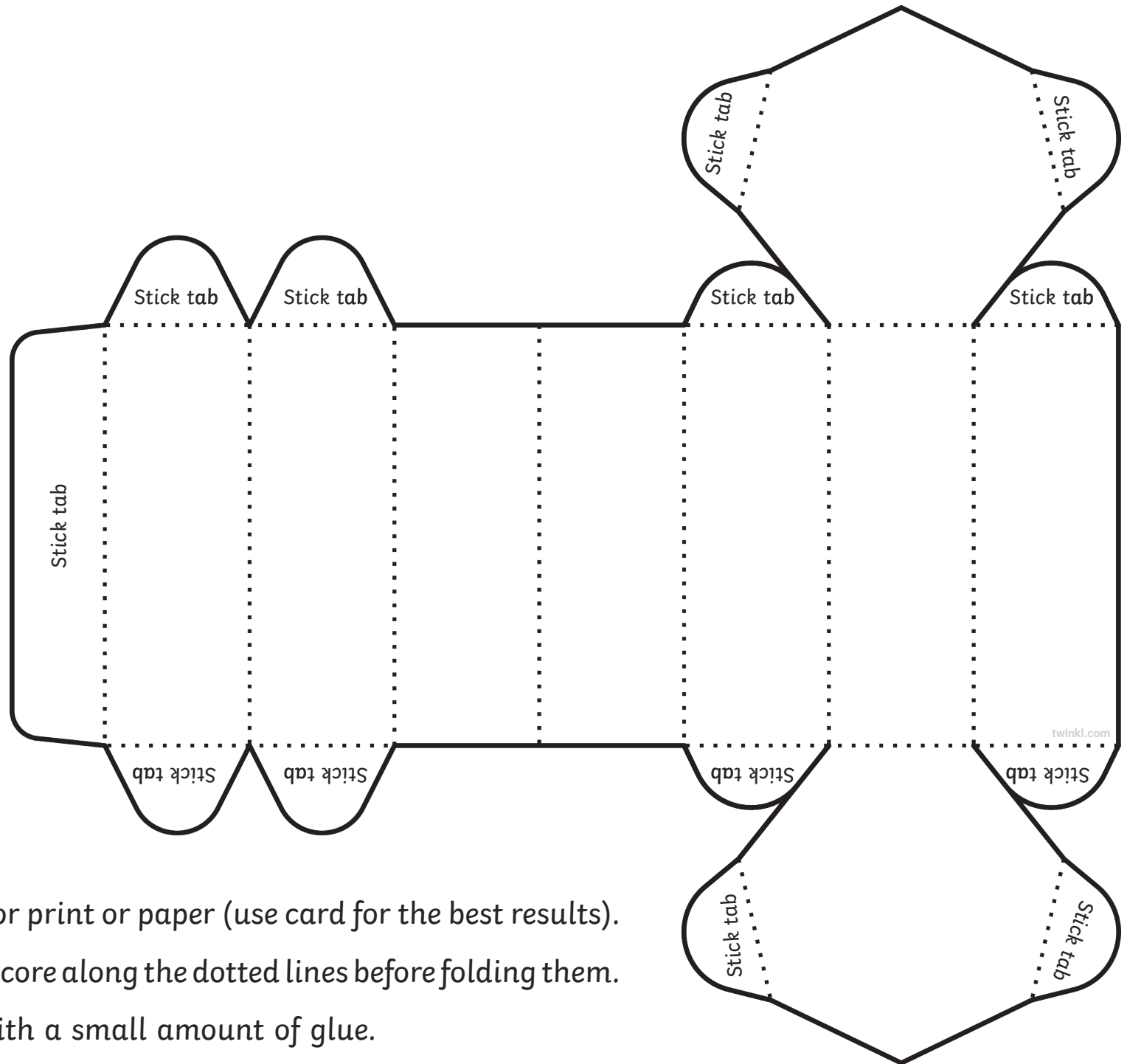

Print the template on card or print on paper (use card for the best results).
Cut the shape out and then score along the dotted lines before folding them.
Stick the shape together with a small amount of glue.

3D Objects

This is a net for a tetrahedron.

Print it out and then stick it onto thin card. Cut it out and then score along the lines and fold them. Stick together with small amounts of glue.

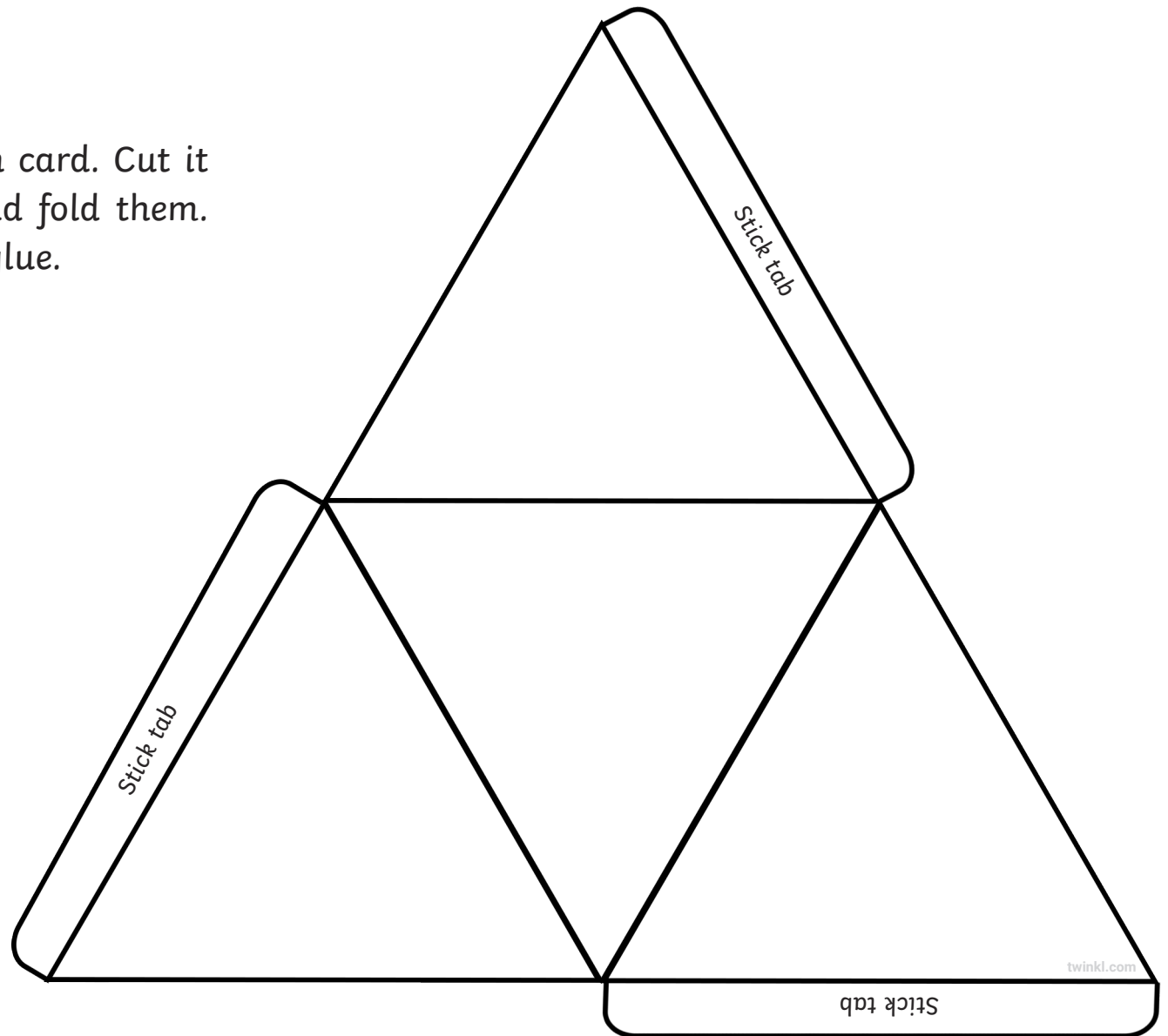

3D Objects

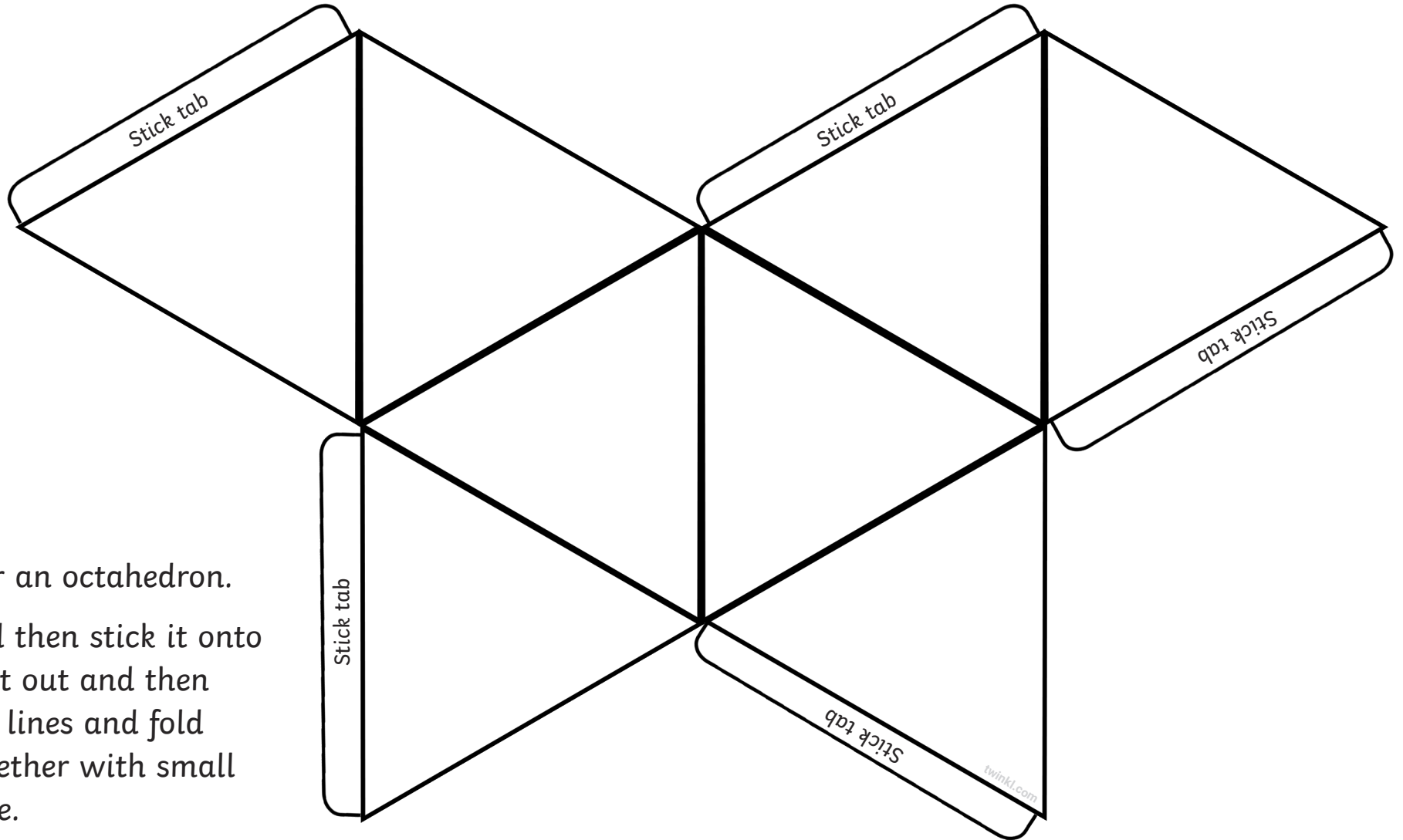

This is a net for an octahedron.
Print it out and then stick it onto thin card. Cut it out and then score along the lines and fold them. Stick together with small amounts of glue.

3D Objects

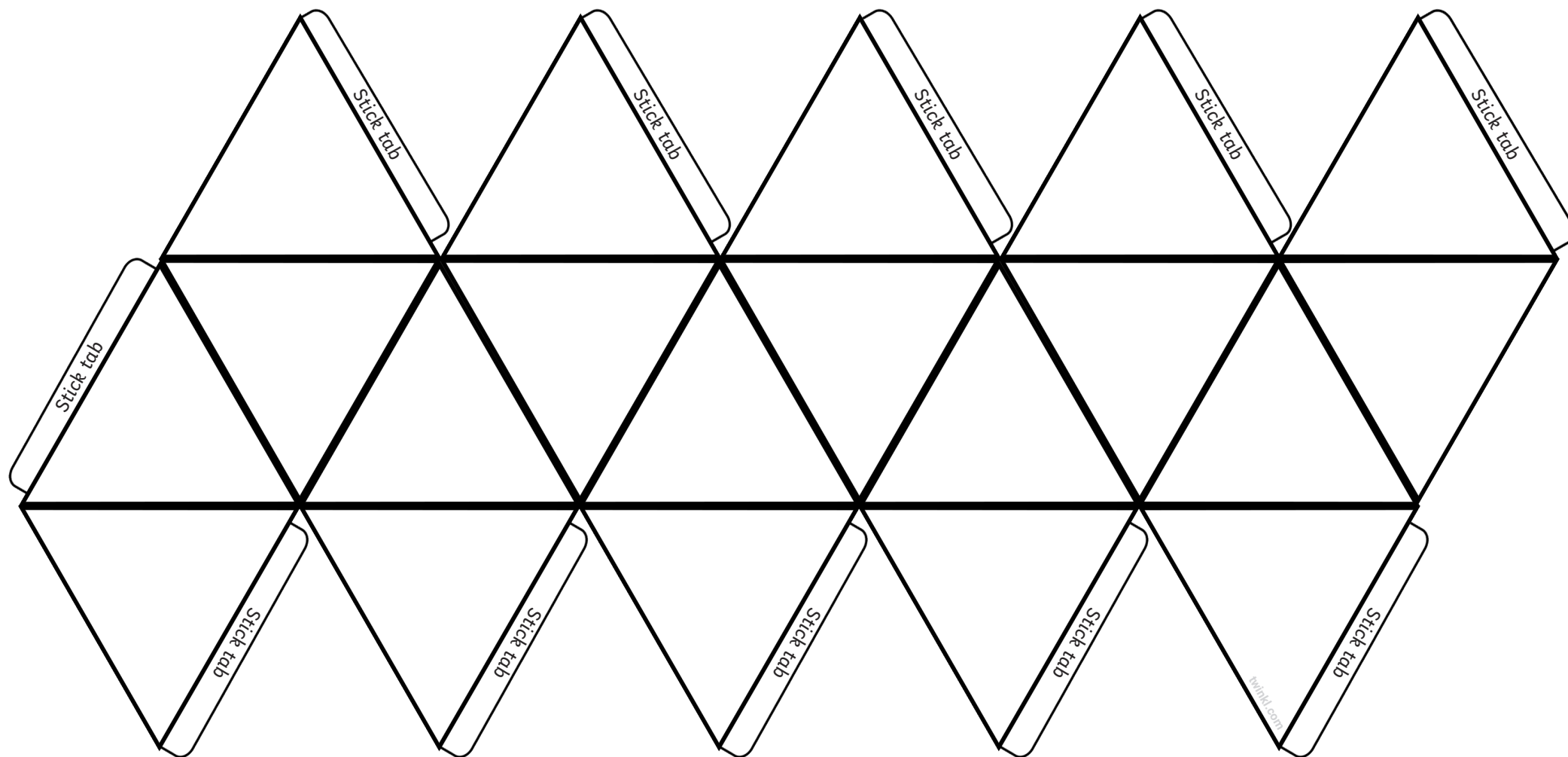

This is a net for an icosahedron.

Print it out and then stick it onto thin card. Cut it out and then score along the lines and fold them. Stick together with small amounts of glue.

3D Objects

This is a net for a cylinder.

Print it out and then stick it onto thin card. Cut it out and then score along the lines and fold them. Stick together with small amounts of glue.

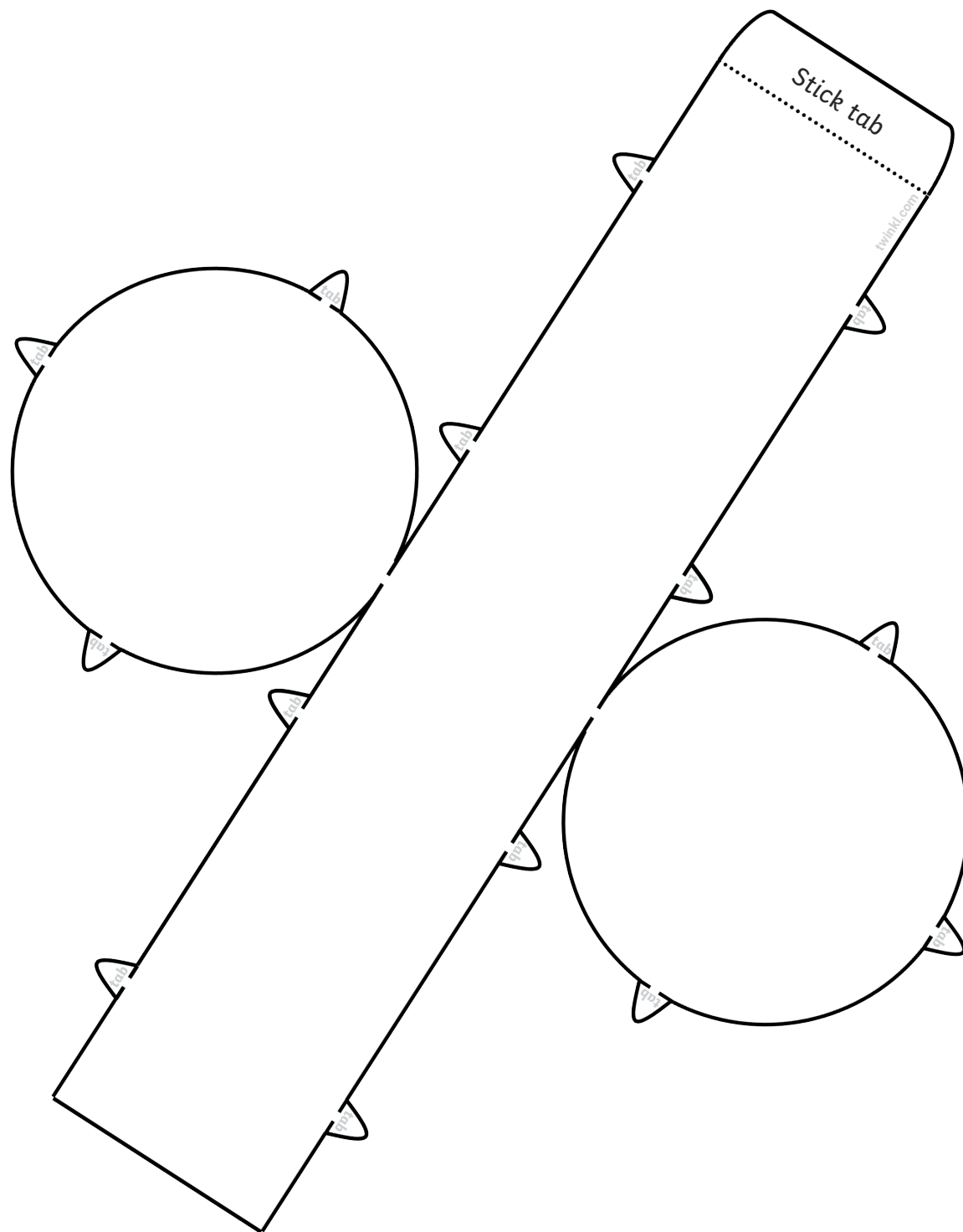

3D Objects

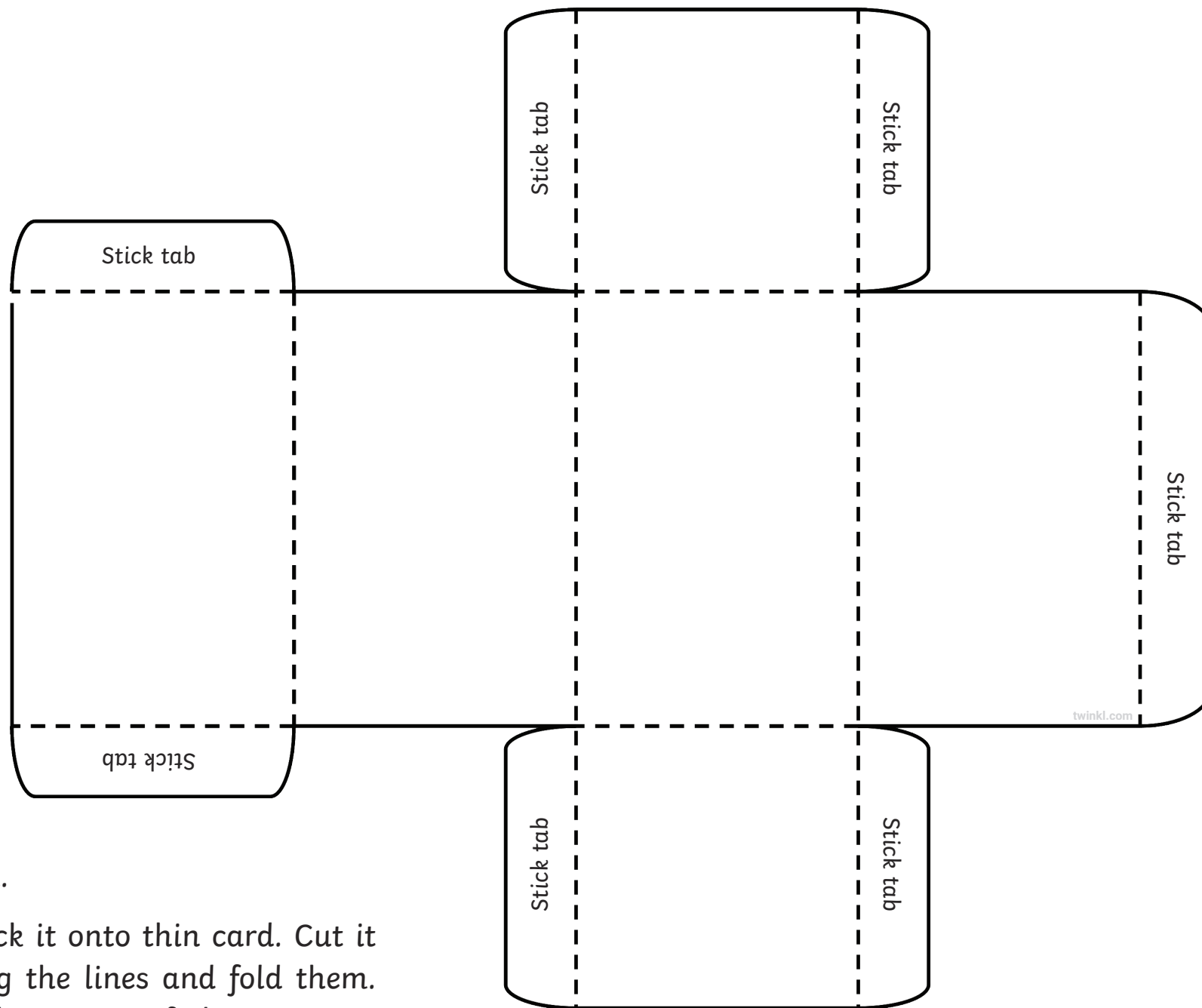

This is a net for a cuboid.

Print it out and then stick it onto thin card. Cut it out and then score along the lines and fold them. Stick together with small amounts of glue.

3D Objects

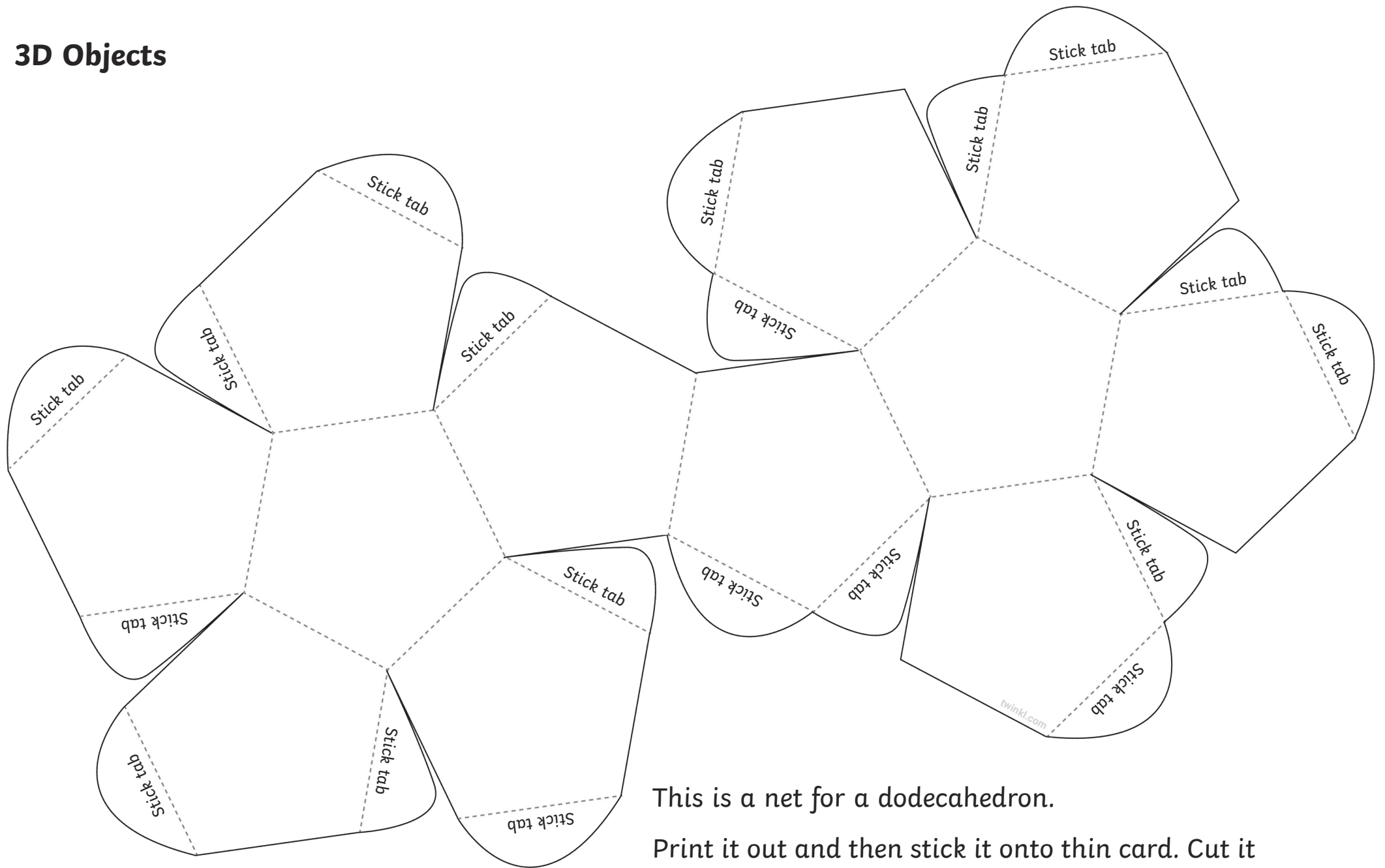

This is a net for a dodecahedron.

Print it out and then stick it onto thin card. Cut it out and then score along the lines and fold them. Stick together with small amounts of glue.

3D Objects

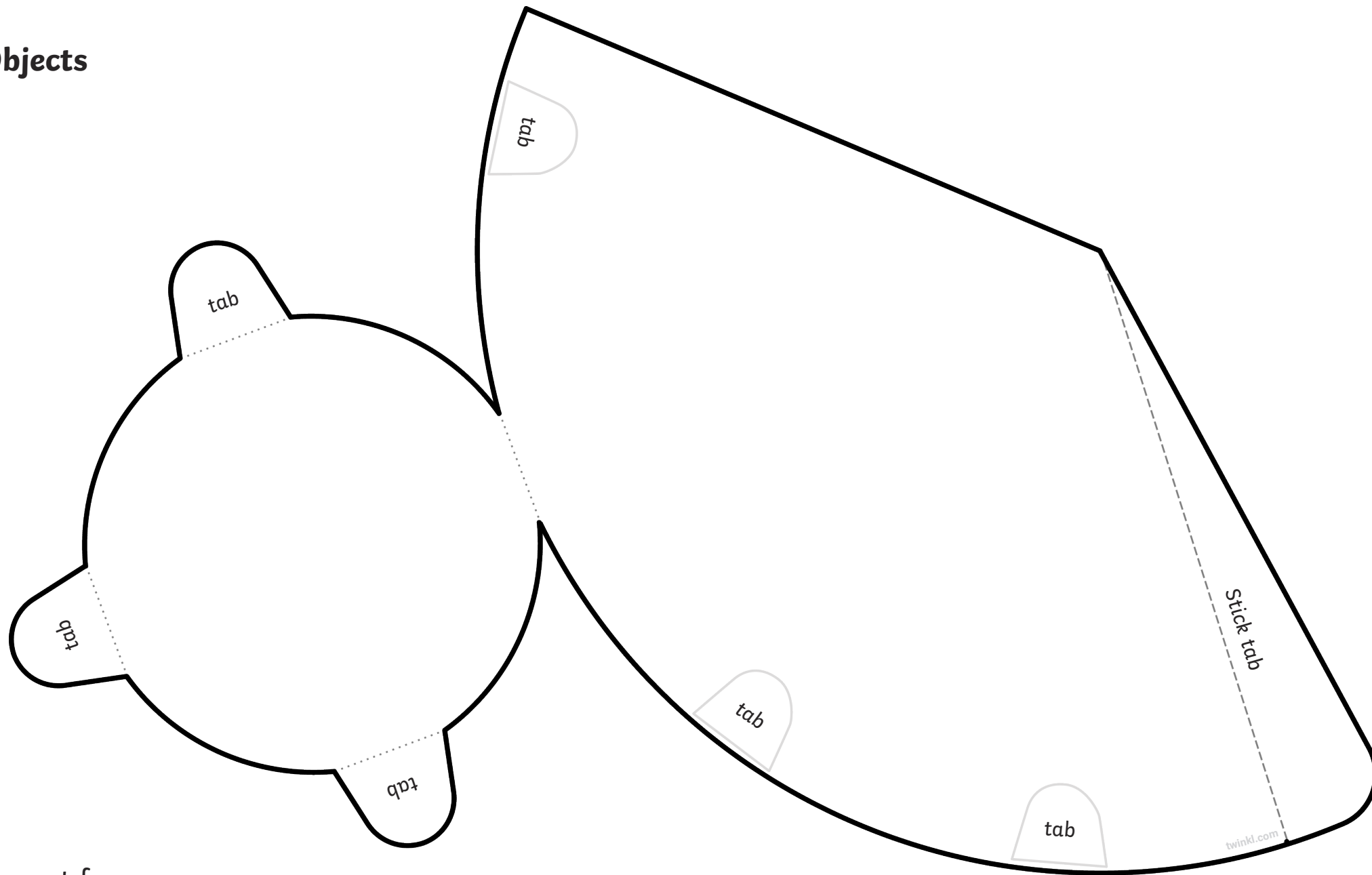

This is a net for a cone.

Print it out and then stick it onto thin card. Cut it out and then score along the lines and fold them. Stick together with small amounts of glue.